





- Ø 150** Pijpdiameter (mm)  
Pipe diameter (mm)  
Diamètre buse (mm)  
Abgasstutzen (mm)
- KG 80** Gewicht (kg)  
Weight (kg)  
Poids (kg)  
Gewicht (kg)
-  Binnenwerk vermiculiet  
Vermiculite panels inside  
Intérieur vermiculite  
Innenbekleidung Vermiculiet

- % 85,0** Efficiëntie  
Efficiency  
Efficacité  
Effizienz
-  Bovenaansluiting  
Connection top  
Raccordement dessus  
Anschluss oben

- kW 5,5** Vermogen output (kW)  
Capacity output (kW)  
Puissance output (kW)  
Leistung output (kW)
-  Externe luchttoevoer  
External air supply  
Prise d'air extérieure  
Externer Luftanschluss

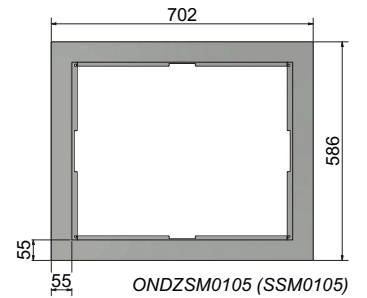
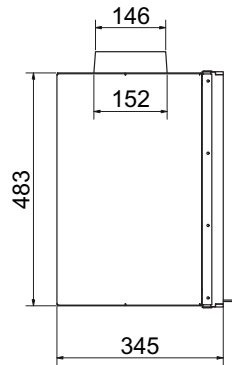
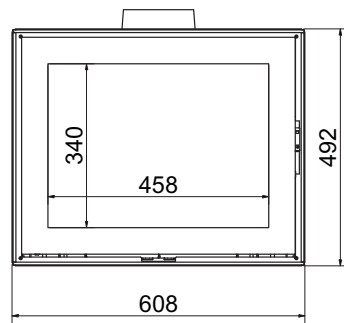
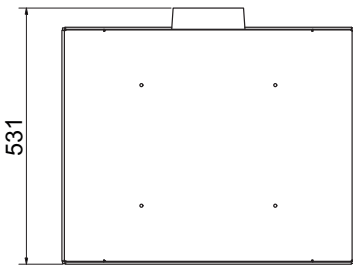
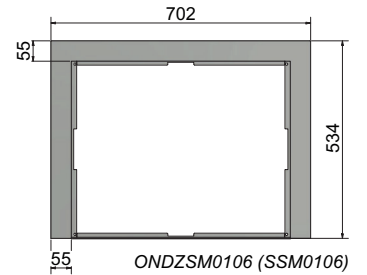
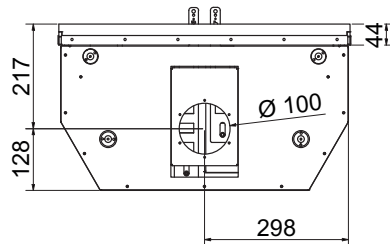
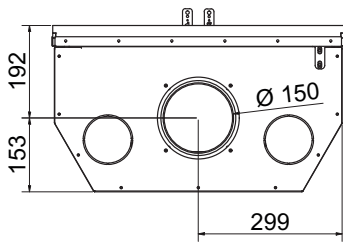

WAN-2060 F incl. 6 mm frame (ONDZSM0104)

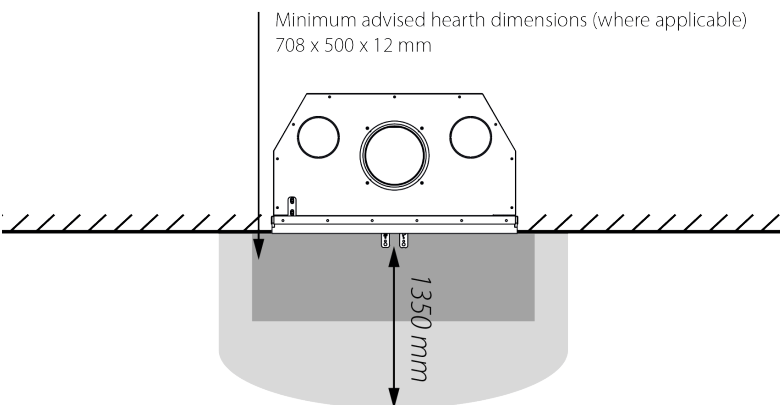



**ENERG**

енергия · енерґія

Y IA  
IE IA

**wanders WAN-2060 F**

fires & stoves

A++

A+

A

B

C

D

E

F

G

**A+**

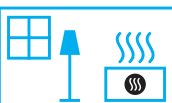

**5,5**  
kW

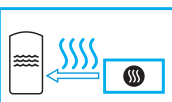

**-**  
kW

ENERGIA · ЕНЕРґІЯ · ЕΝΕΡΓΕΙΑ · ENERGIJA · ENERGY · ENERGIE · ENERGI

2015/1186